

MJE18004D2

High Speed, High Gain Bipolar NPN Power Transistor with Integrated Collector-Emitter Diode and Built-in Efficient Antisaturation Network

The MJE18004D2 is state-of-art High Speed High gain BIPolar transistor (H2BIP). High dynamic characteristics and lot to lot minimum spread (± 150 ns on storage time) make it ideally suitable for light ballast applications. Therefore, there is no need to guarantee an h_{FE} window.

It's characteristics make it also suitable for PFC application.

Features

- Low Base Drive Requirement
- High Peak DC Current Gain (55 Typical) @ $I_C = 100$ mA
- **Extremely Low Storage Time Min/Max Guarantees Due to the H2BIP Structure which Minimizes the Spread**
- Integrated Collector-Emitter Free Wheeling Diode
- Fully Characterized and Guaranteed Dynamic $V_{CE(sat)}$
- "6 Sigma" Process Providing Tight and Reproducible Parameter Spreads
- Pb-Free Package is Available*

MAXIMUM RATINGS ($T_J = 25^\circ\text{C}$ unless otherwise noted)

Rating	Symbol	Value	Unit
Collector-Emitter Sustaining Voltage	V_{CEO}	450	Vdc
Collector-Base Breakdown Voltage	V_{CBO}	1000	Vdc
Collector-Emitter Breakdown Voltage	V_{CES}	1000	Vdc
Emitter-Base Voltage	V_{EBO}	12	Vdc
Collector Current – Continuous – Peak (Note 1)	I_C I_{CM}	5 10	Adc
Base Current – Continuous – Peak (Note 1)	I_B I_{BM}	2 4	Adc
Total Device Dissipation @ $T_C = 25^\circ\text{C}$ Derate above 25°C	P_D	75 0.6	W W/ $^\circ\text{C}$
Operating and Storage Temperature	T_J, T_{stg}	-65 to 150	$^\circ\text{C}$

THERMAL CHARACTERISTICS

Thermal Resistance, Junction-to-Case	$R_{\theta JC}$	1.65	$^\circ\text{C/W}$
Thermal Resistance, Junction-to-Ambient	$R_{\theta JA}$	62.5	$^\circ\text{C/W}$
Maximum Lead Temperature for Soldering Purposes: 1/8" from Case for 5 Seconds	T_L	260	$^\circ\text{C}$

Stresses exceeding Maximum Ratings may damage the device. Maximum Ratings are stress ratings only. Functional operation above the Recommended Operating Conditions is not implied. Extended exposure to stresses above the Recommended Operating Conditions may affect device reliability.

1. Pulse Test: Pulse Width = 5 ms, Duty Cycle $\leq 10\%$.



ON Semiconductor®

<http://onsemi.com>

POWER TRANSISTORS
5 AMPERES,
1000 VOLTS, 75 WATTS

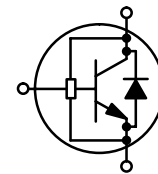

MARKING DIAGRAM

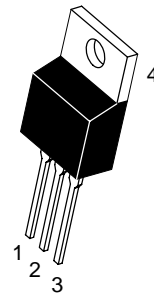

TO-220AB
CASE 221A
STYLE 1

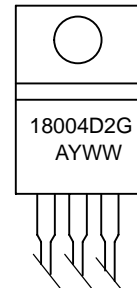

18004D2 = Device Code
G = Pb-Free Package
A = Assembly Location
Y = Year
WW = Work Week

ORDERING INFORMATION

Device	Package	Shipping†
MJE18004D2	TO-220AB	50 Units / Rail
MJE18004D2G	TO-220AB (Pb-Free)	50 Units / Rail

*For additional information on our Pb-Free strategy and soldering details, please download the ON Semiconductor Soldering and Mounting Techniques Reference Manual, SOLDERRM/D.

MJE18004D2

ELECTRICAL CHARACTERISTICS ($T_C = 25^\circ\text{C}$ unless otherwise noted)

Characteristic	Symbol	Min	Typ	Max	Unit			
OFF CHARACTERISTICS								
Collector–Emitter Sustaining Voltage ($I_C = 100\text{ mA}$, $L = 25\text{ mH}$)	$V_{CEO(sus)}$	450	547	–	Vdc			
Collector–Base Breakdown Voltage ($I_{CBO} = 1\text{ mA}$)	V_{CB0}	1000	1100	–	Vdc			
Emitter–Base Breakdown Voltage ($I_{EBO} = 1\text{ mA}$)	V_{EBO}	12	14	–	Vdc			
Collector Cutoff Current ($V_{CE} = \text{Rated } V_{CE0}$, $I_B = 0$)	I_{CE0}	–	–	100	μAdc			
Collector Cutoff Current ($V_{CE} = \text{Rated } V_{CES}$, $V_{EB} = 0$) ($V_{CE} = 500\text{ V}$, $V_{EB} = 0$)	I_{CES}	–	–	100 500 100	μAdc			
Emitter–Cutoff Current ($V_{EB} = 10\text{ Vdc}$, $I_C = 0$)	I_{EBO}	–	–	100	μAdc			
ON CHARACTERISTICS								
Base–Emitter Saturation Voltage ($I_C = 0.8\text{ Adc}$, $I_B = 80\text{ mA}$) ($I_C = 2\text{ Adc}$, $I_B = 0.4\text{ Adc}$)	$V_{BE(sat)}$	–	0.8 0.7	1 0.9	Vdc			
Collector–Emitter Saturation Voltage ($I_C = 0.8\text{ Adc}$, $I_B = 80\text{ mA}$) ($I_C = 2\text{ Adc}$, $I_B = 0.4\text{ Adc}$) ($I_C = 0.8\text{ Adc}$, $I_B = 40\text{ mA}$) ($I_C = 1\text{ Adc}$, $I_B = 0.2\text{ Adc}$)	$V_{CE(sat)}$	–	0.38 0.55 0.45 0.75 0.9 1.6 0.25 0.28	0.5 0.75 0.75 1 1.5 0.5 0.6	Vdc			
DC Current Gain ($I_C = 0.8\text{ Adc}$, $V_{CE} = 1\text{ Vdc}$) ($I_C = 2\text{ Adc}$, $V_{CE} = 1\text{ Vdc}$) ($I_C = 1\text{ Adc}$, $V_{CE} = 2.5\text{ Vdc}$)	h_{FE}	15 10 6 4 18 14	28 14 8 6 28 20	– – – –	–			
DYNAMIC SATURATION VOLTAGE								
Dynamic Saturation Voltage: Determined 1 μs and 3 μs respectively after rising I_{B1} reaches 90% of final I_{B1}	$I_C = 1\text{ Adc}$ $I_{B1} = 100\text{ mA}$ $V_{CC} = 300\text{ V}$	@ 1 μs	@ $T_C = 25^\circ\text{C}$ @ $T_C = 125^\circ\text{C}$	$V_{CE(dsat)}$	–	9 16	–	V
		@ 3 μs	@ $T_C = 25^\circ\text{C}$ @ $T_C = 125^\circ\text{C}$	–	3.1 9	–		
	$I_C = 2\text{ Adc}$ $I_{B1} = 0.4\text{ A}$ $V_{CC} = 300\text{ V}$	@ 1 μs	@ $T_C = 25^\circ\text{C}$ @ $T_C = 125^\circ\text{C}$	–	11 18	–		
		@ 3 μs	@ $T_C = 25^\circ\text{C}$ @ $T_C = 125^\circ\text{C}$	–	1.4 8	–		

MJE18004D2

ELECTRICAL CHARACTERISTICS (T_C = 25°C unless otherwise noted)

Characteristic	Symbol	Min	Typ	Max	Unit
----------------	--------	-----	-----	-----	------

DIODE CHARACTERISTICS

Forward Diode Voltage (I _{EC} = 1 Adc) (I _{EC} = 2 Adc)	@ T _C = 25°C @ T _C = 125°C	V _{EC}	-	0.96 0.72	1.5	V
	@ T _C = 25°C @ T _C = 125°C		-	1.15 0.8	1.7	
Forward Recovery Time (I _F = 0.4 Adc, di/dt = 10 A/μs) (I _F = 1 Adc, di/dt = 10 A/μs) (I _F = 2 Adc, di/dt = 10 A/μs)	@ T _C = 25°C	t _{fr}	-	440	-	ns
	@ T _C = 25°C		-	335	-	
	@ T _C = 25°C		-	335	-	

DYNAMIC CHARACTERISTICS

Current Gain Bandwidth (I _C = 0.5 Adc, V _{CE} = 10 Vdc, f = 1 MHz)	f _T	-	13	-	MHz
Output Capacitance (V _{CB} = 10 Vdc, I _E = 0, f = 1 MHz)	C _{ob}	-	60	100	pF
Input Capacitance (I _C = 0.5 Adc, V _{CE} = 10 Vdc, f = 1 MHz)	C _{ib}	-	450	750	pF

SWITCHING CHARACTERISTICS: Resistive Load (D.C. ≤ 10%, Pulse Width = 40 μs)

Turn-on Time	I _C = 2.5 Adc, I _{B1} = 0.5 Adc I _{B2} = 1 Adc V _{CC} = 250 Vdc	@ T _C = 25°C	t _{on}	-	500	750	ns
Turn-off Time		@ T _C = 25°C	t _{off}	1.1	-	1.4	μs
Turn-on Time	I _C = 2 Adc, I _{B1} = 0.4 Adc I _{B2} = 1 Adc V _{CC} = 300 Vdc	@ T _C = 25°C @ T _C = 125°C	t _{on}	-	100 150	150	ns
Turn-off Time		@ T _C = 25°C @ T _C = 125°C	t _{off}	-	1.15 1.6	1.3	μs
Turn-on Time	I _C = 2.5 Adc, I _{B1} = 0.5 Adc I _{B2} = 0.5 Adc V _{CC} = 300 Vdc	@ T _C = 25°C @ T _C = 125°C	t _{on}	-	120 500	150	ns
Turn-off Time		@ T _C = 25°C @ T _C = 125°C	t _{off}	1.85	- 2.6	2.15	μs

SWITCHING CHARACTERISTICS: Inductive Load (V_{CC} = 15 V)

Fall Time	I _C = 2.5 Adc I _{B1} = 500 mAdc I _{B2} = 500 mAdc V _Z = 350 V L _C = 300 μH	@ T _C = 25°C @ T _C = 125°C	t _f	-	130 300	175	ns
Storage Time		@ T _C = 25°C @ T _C = 125°C	t _s	-	2.12 2.6	2.4	μs
Crossover Time		@ T _C = 25°C @ T _C = 125°C	t _c	-	355 750	500	ns
Fall Time	I _C = 2 Adc I _{B1} = 400 mAdc I _{B2} = 400 mAdc V _Z = 300 V L _C = 200 μH	@ T _C = 25°C @ T _C = 125°C	t _f	-	95 230	150	ns
Storage Time		@ T _C = 25°C @ T _C = 125°C	t _s	2.1	-	2.4	μs
Crossover Time		@ T _C = 25°C @ T _C = 125°C	t _c	-	300 700	450	ns
Fall Time	I _C = 1 Adc I _{B1} = 100 mAdc I _{B2} = 500 mAdc V _Z = 300 V L _C = 200 μH	@ T _C = 25°C @ T _C = 125°C	t _f	-	70 100	90	ns
Storage Time		@ T _C = 25°C @ T _C = 125°C	t _s	-	0.7 1.05	0.9	μs
Crossover Time		@ T _C = 25°C @ T _C = 125°C	t _c	-	75 160	120	ns

TYPICAL STATIC CHARACTERISTICS

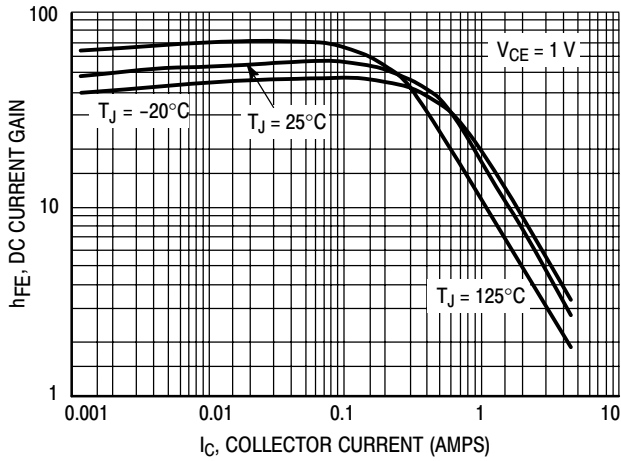

Figure 1. DC Current Gain @ 1 Volt

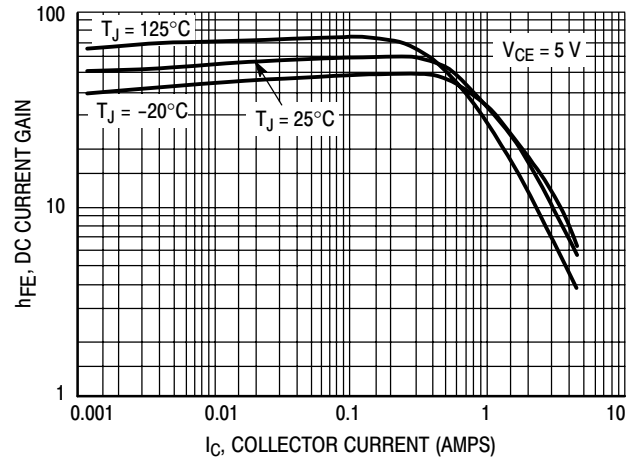

Figure 2. DC Current Gain @ 5 Volt

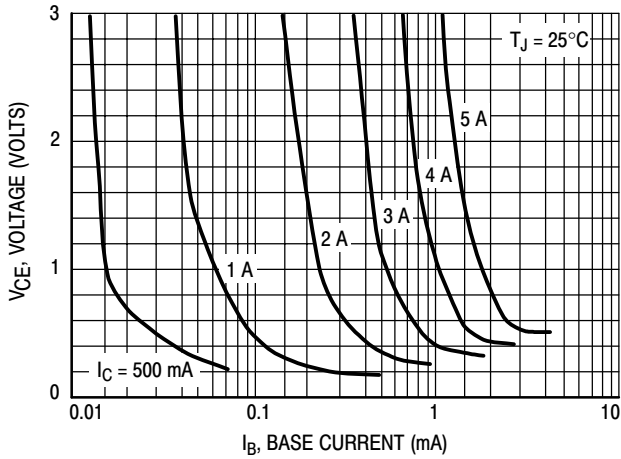

Figure 3. Collector Saturation Region

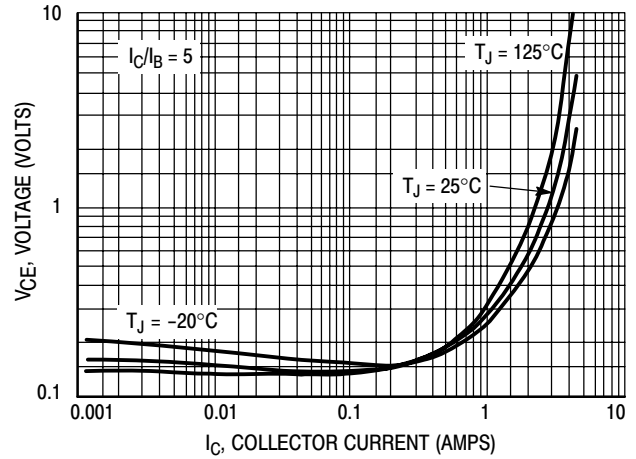

Figure 4. Collector-Emitter Saturation Voltage

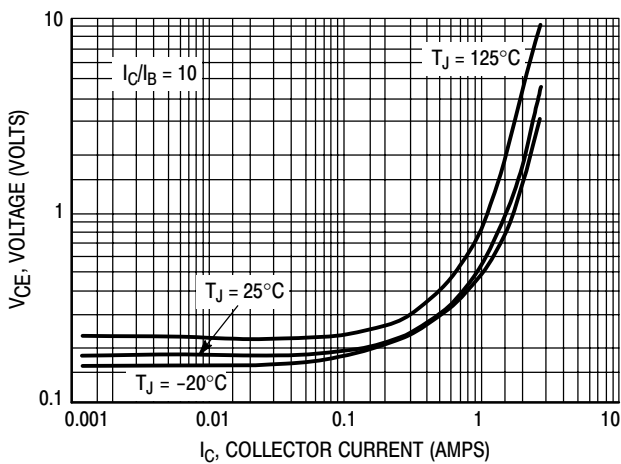

Figure 5. Collector-Emitter Saturation Voltage

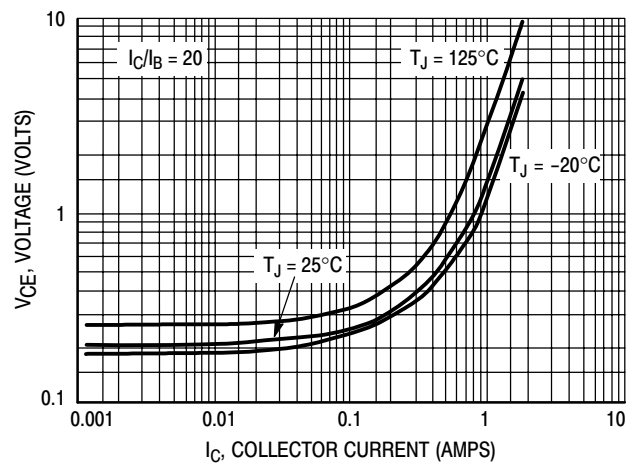

Figure 6. Collector-Emitter Saturation Voltage

TYPICAL STATIC CHARACTERISTICS

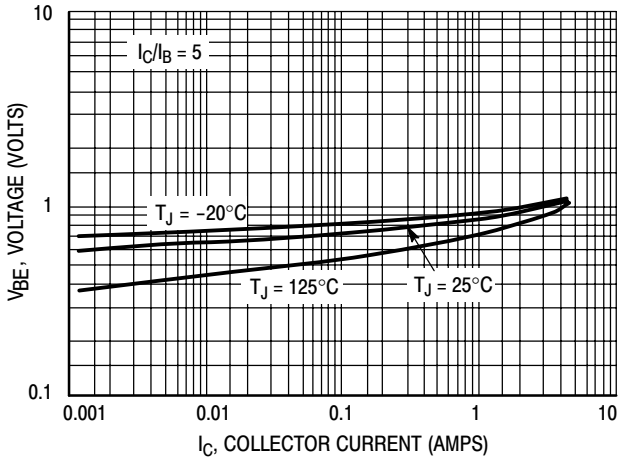

Figure 7. Base-Emitter Saturation Region

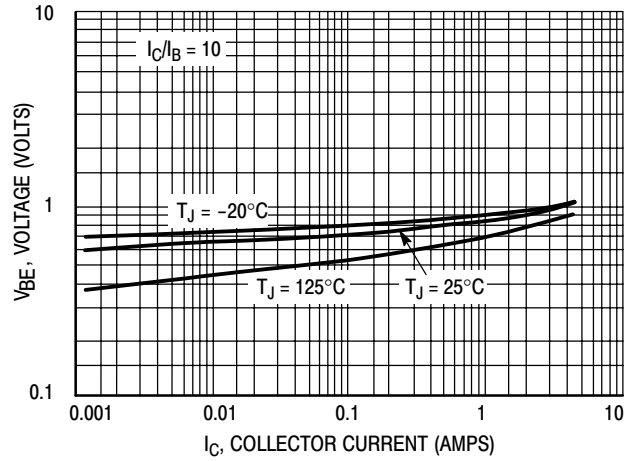

Figure 8. Base-Emitter Saturation Region

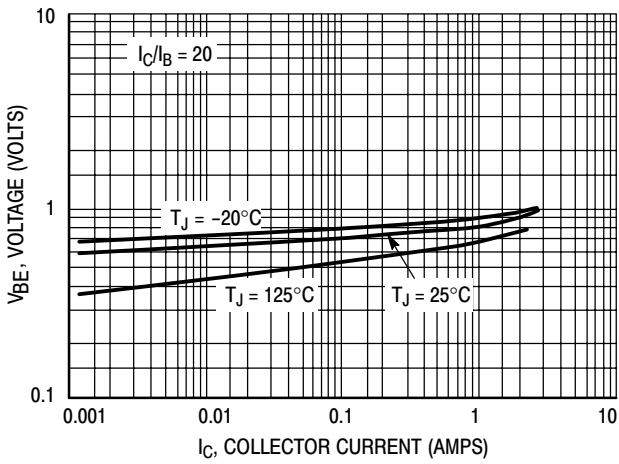

Figure 9. Base-Emitter Saturation Region

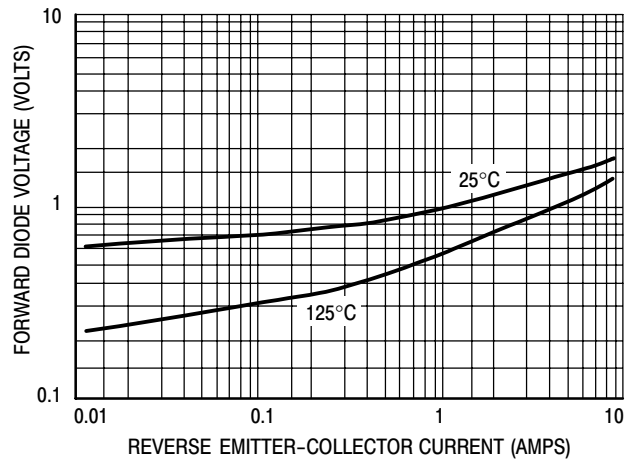

Figure 10. Forward Diode Voltage

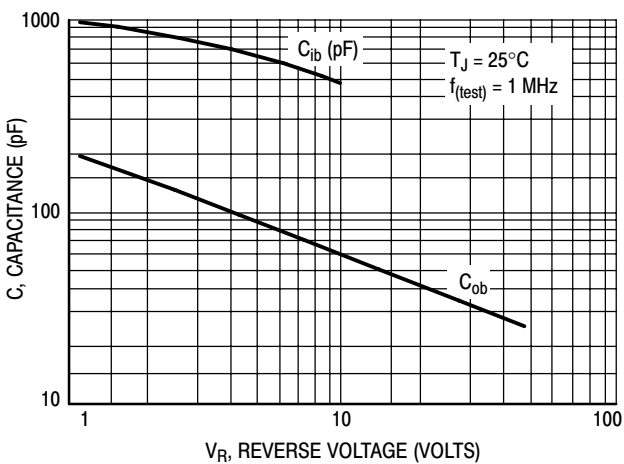

Figure 11. Capacitance

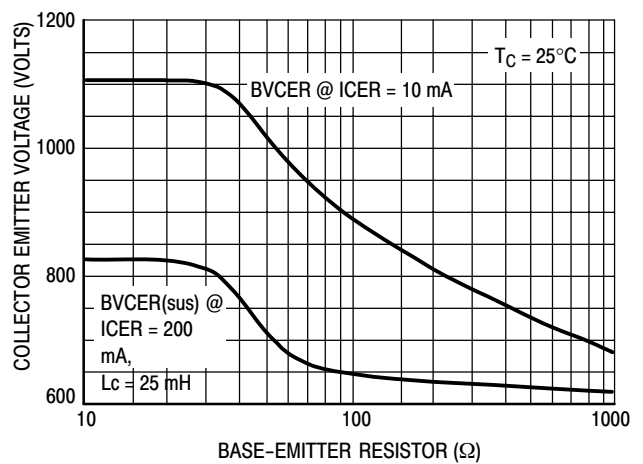

Figure 12. BVCER = f(R_{BE})

TYPICAL SWITCHING CHARACTERISTICS

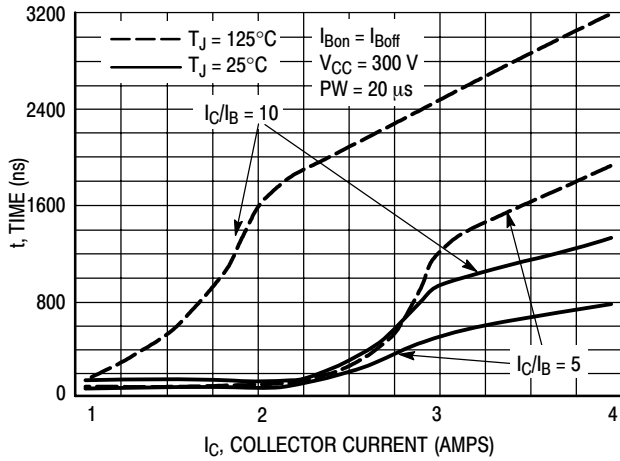

Figure 13. Resistive Switch Time, t_{on}

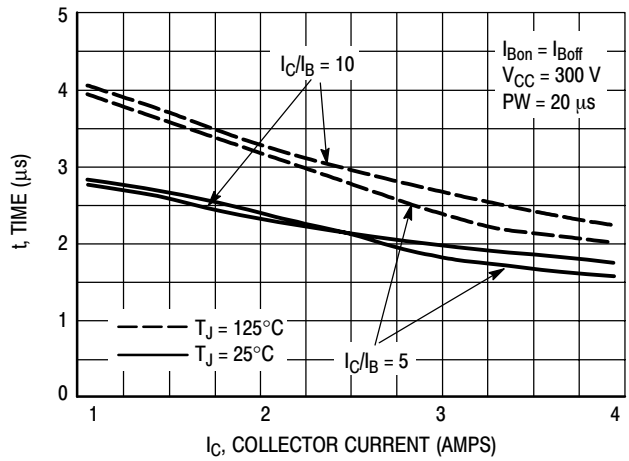

Figure 14. Resistive Switch Time, t_{off}

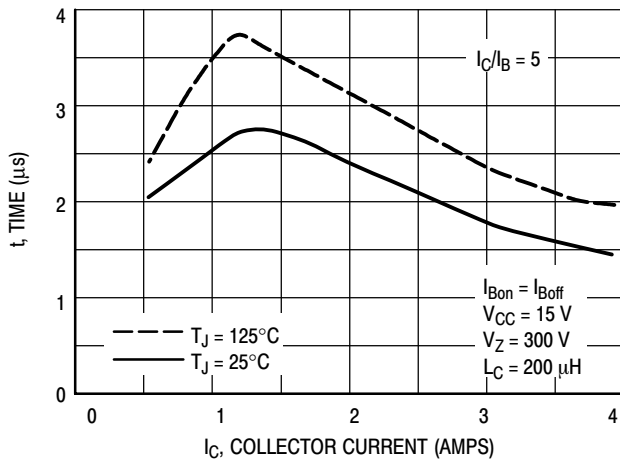

Figure 15. Inductive Storage Time, t_{si} @ $I_C/I_B = 5$

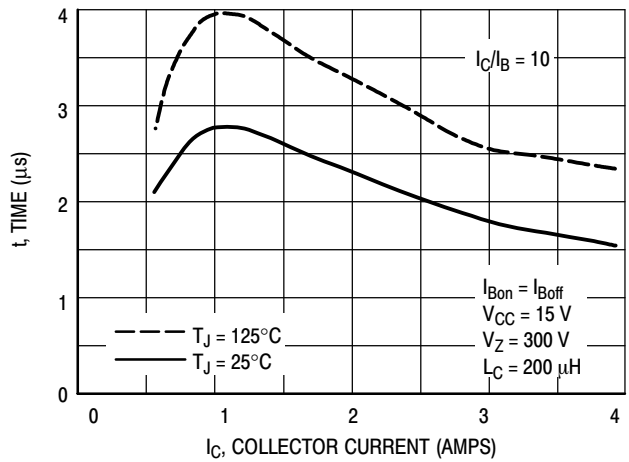

Figure 16. Inductive Storage Time, t_{si} @ $I_C/I_B = 10$

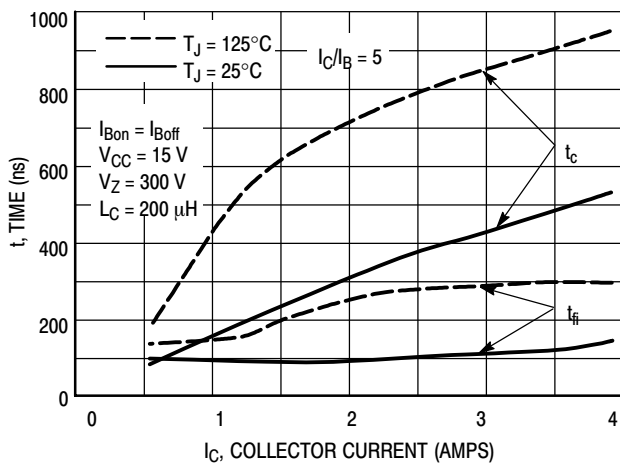

Figure 17. Inductive Switching Time, t_c and t_{fi} @ $I_C/I_B = 5$

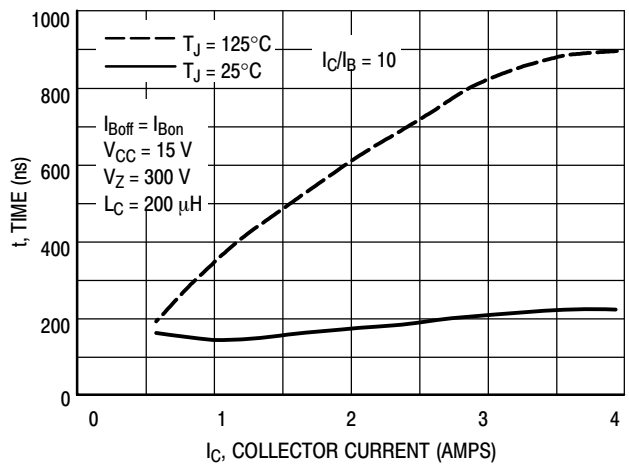

Figure 18. Inductive Switching Time, t_{fi} @ $I_C/I_B = 10$

TYPICAL SWITCHING CHARACTERISTICS

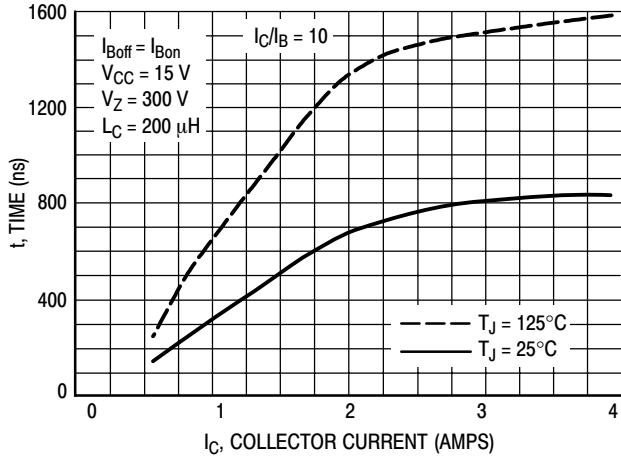

Figure 19. Inductive Switching, t_c @ $I_C/I_B = 10$

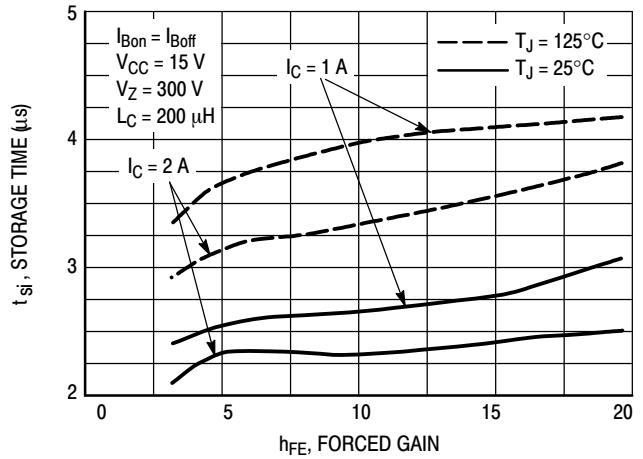

Figure 20. Inductive Storage Time

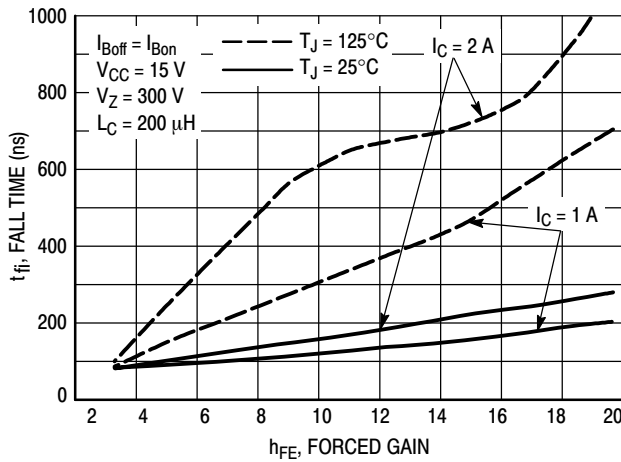

Figure 21. Inductive Fall Time

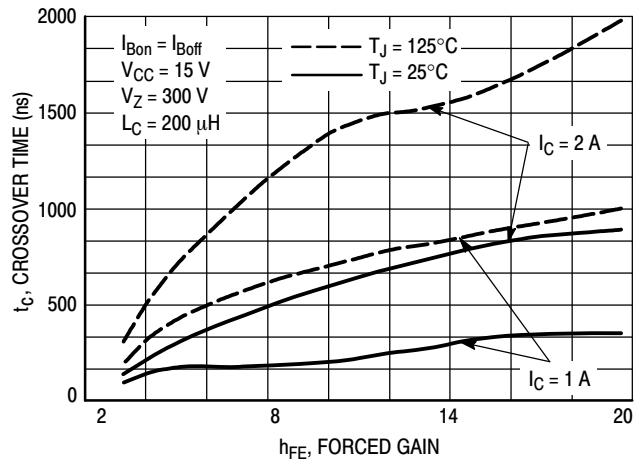

Figure 22. Inductive Crossover Time

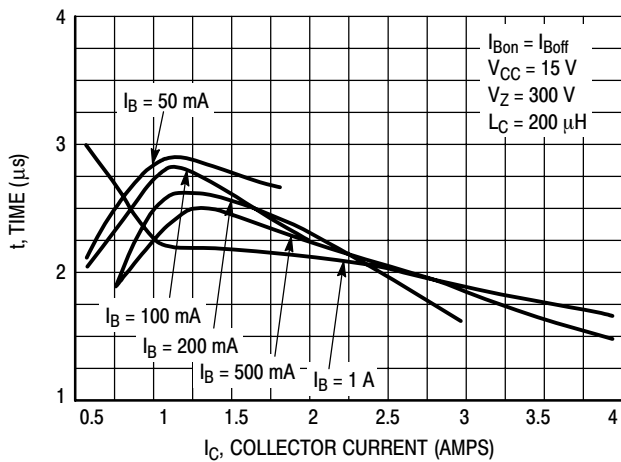

Figure 23. Inductive Storage Time, t_{si}

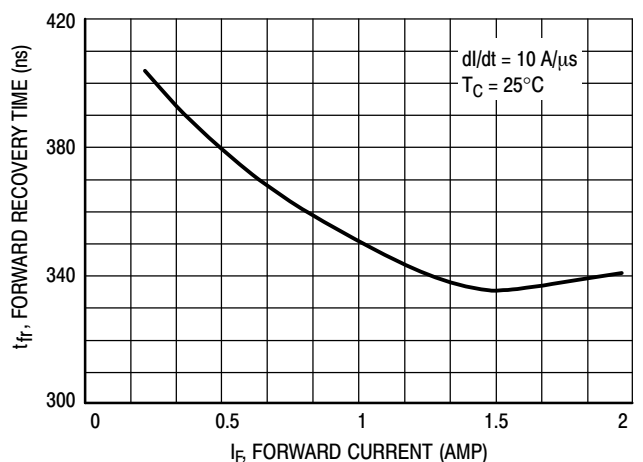

Figure 24. Forward Recovery Time, T_{FR}

MJE18004D2

TYPICAL SWITCHING CHARACTERISTICS

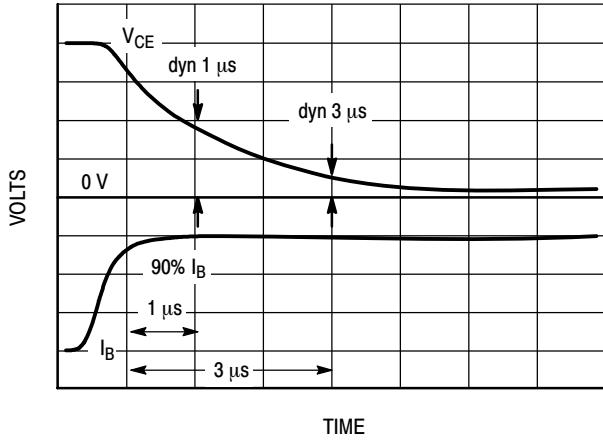

Figure 25. Dynamic Saturation Voltage Measurements

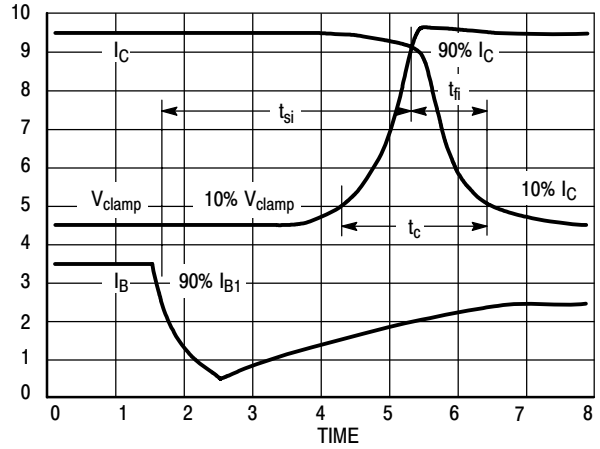

Figure 26. Inductive Switching Measurements

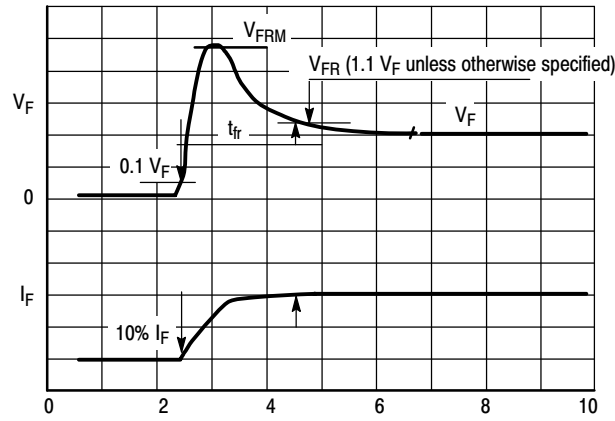
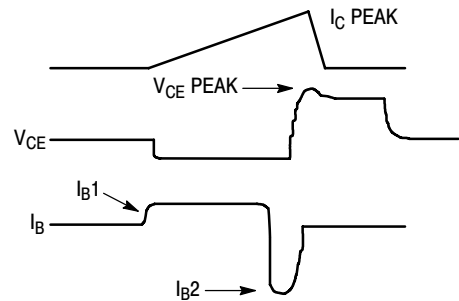
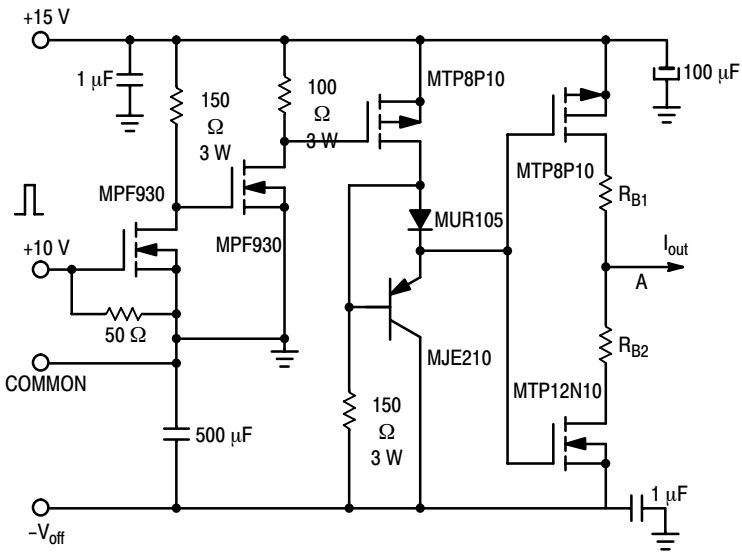

Figure 27. t_{fr} Measurements



$V_{(BR)CEO(sus)}$	Inductive Switching	RBSOA
$L = 10 \text{ mH}$	$L = 200 \text{ } \mu\text{H}$	$L = 500 \text{ } \mu\text{H}$
$RB2 = \infty$	$RB2 = 0$	$RB2 = 0$
$V_{CC} = 20 \text{ V}$	$V_{CC} = 15 \text{ V}$	$V_{CC} = 15 \text{ V}$
$I_{C(pk)} = 100 \text{ mA}$	$RB1$ selected for desired I_{B1}	$RB1$ selected for desired I_{B1}

Table 1. Inductive Load Switching Drive Circuit

TYPICAL CHARACTERISTICS

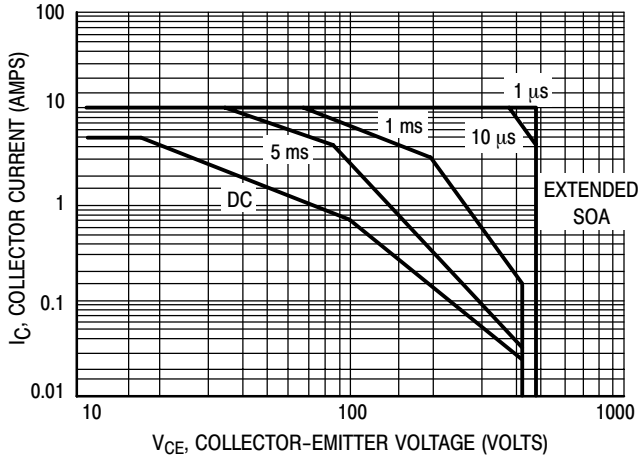

Figure 28. Forward Bias Safe Operating Area

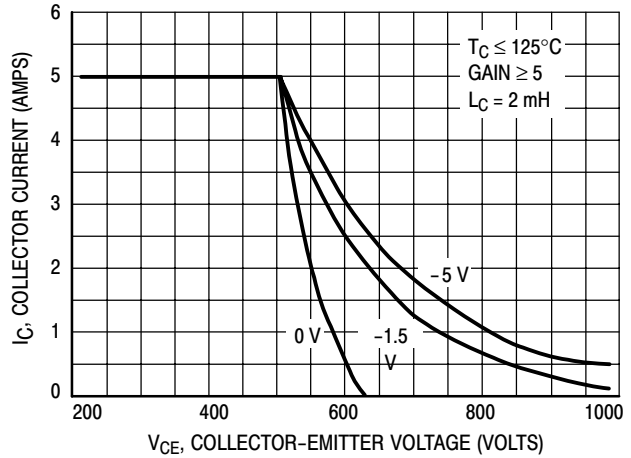

Figure 29. Reverse Bias Safe Operating Area

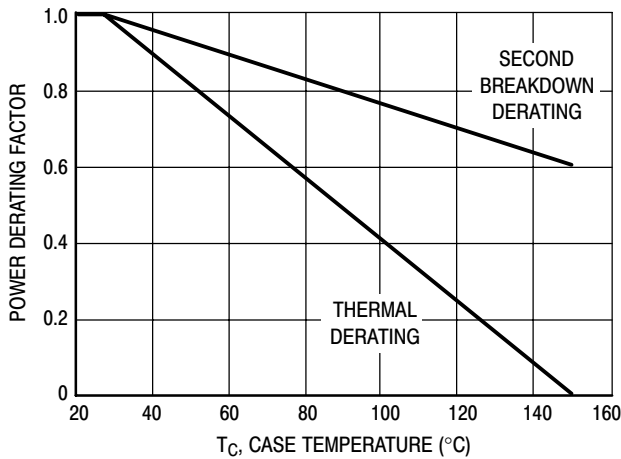

Figure 30. Forward Bias Power Derating

There are two limitations on the power handling ability of a transistor: average junction temperature and second breakdown. Safe operating area curves indicate I_C - V_{CE} limits of the transistor that must be observed for reliable operation; i.e., the transistor must not be subjected to greater dissipation than the curves indicate. The data of Figure 28 is based on $T_C = 25^\circ\text{C}$; $T_J(\text{pk})$ is variable depending on power level. Second breakdown pulse limits are valid for duty cycles to 10% but must be derated when $T_C > 25^\circ\text{C}$. Second breakdown limitations do not derate the same as thermal limitations. Allowable current at the voltages shown on Figure 28 may be found at any case temperature by using the appropriate curve on Figure 30.

$T_J(\text{pk})$ may be calculated from the data in Figure 31. At any case temperatures, thermal limitations will reduce the power that can be handled to values less than the limitations imposed by second breakdown. For inductive loads, high voltage and current must be sustained simultaneously during turn-off with the base-to-emitter junction reverse biased. The safe level is specified as a reverse-biased safe operating area (Figure 29). This rating is verified under clamped conditions so that the device is never subjected to an avalanche mode.

TYPICAL THERMAL RESPONSE

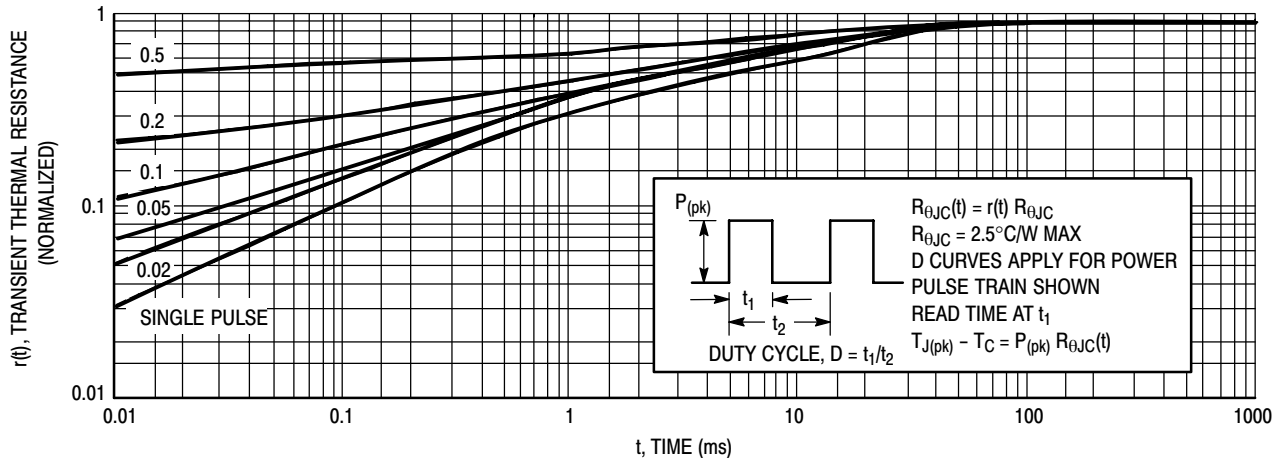
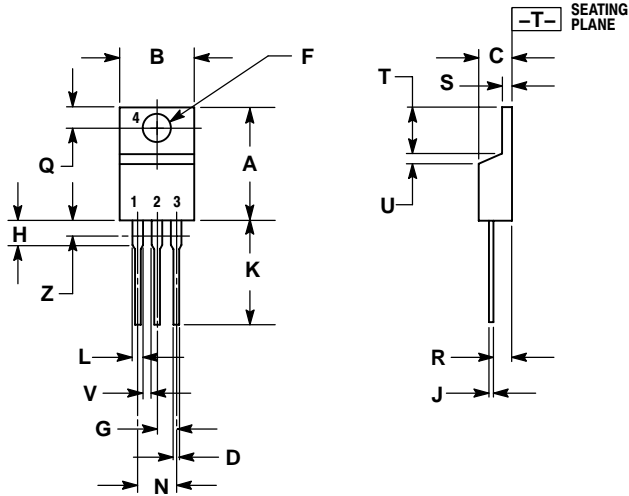

Figure 31. Typical Thermal Response ($Z_{\theta JC}(t)$) for MJE18004D2

MJE18004D2

PACKAGE DIMENSIONS

TO-220AB
CASE 221A-09
ISSUE AD



NOTES:

1. DIMENSIONING AND TOLERANCING PER ANSI Y14.5M, 1982.
2. CONTROLLING DIMENSION: INCH.
3. DIMENSION Z DEFINES A ZONE WHERE ALL BODY AND LEAD IRREGULARITIES ARE ALLOWED.

DIM	INCHES		MILLIMETERS	
	MIN	MAX	MIN	MAX
A	0.570	0.620	14.48	15.75
B	0.380	0.405	9.66	10.28
C	0.160	0.190	4.07	4.82
D	0.025	0.035	0.64	0.88
F	0.142	0.147	3.61	3.73
G	0.095	0.105	2.42	2.66
H	0.110	0.155	2.80	3.93
J	0.018	0.025	0.46	0.64
K	0.500	0.562	12.70	14.27
L	0.045	0.060	1.15	1.52
N	0.190	0.210	4.83	5.33
Q	0.100	0.120	2.54	3.04
R	0.080	0.110	2.04	2.79
S	0.045	0.055	1.15	1.39
T	0.235	0.255	5.97	6.47
U	0.000	0.050	0.00	1.27
V	0.045	---	1.15	---
Z	---	0.080	---	2.04

STYLE 1:

1. BASE
2. COLLECTOR
3. EMITTER
4. COLLECTOR

ON Semiconductor and are registered trademarks of Semiconductor Components Industries, LLC (SCILLC). SCILLC reserves the right to make changes without further notice to any products herein. SCILLC makes no warranty, representation or guarantee regarding the suitability of its products for any particular purpose, nor does SCILLC assume any liability arising out of the application or use of any product or circuit, and specifically disclaims any and all liability, including without limitation special, consequential or incidental damages. "Typical" parameters which may be provided in SCILLC data sheets and/or specifications can and do vary in different applications and actual performance may vary over time. All operating parameters, including "Typicals" must be validated for each customer application by customer's technical experts. SCILLC does not convey any license under its patent rights nor the rights of others. SCILLC products are not designed, intended, or authorized for use as components in systems intended for surgical implant into the body, or other applications intended to support or sustain life, or for any other application in which the failure of the SCILLC product could create a situation where personal injury or death may occur. Should Buyer purchase or use SCILLC products for any such unintended or unauthorized application, Buyer shall indemnify and hold SCILLC and its officers, employees, subsidiaries, affiliates, and distributors harmless against all claims, costs, damages, and expenses, and reasonable attorney fees arising out of, directly or indirectly, any claim of personal injury or death associated with such unintended or unauthorized use, even if such claim alleges that SCILLC was negligent regarding the design or manufacture of the part. SCILLC is an Equal Opportunity/Affirmative Action Employer. This literature is subject to all applicable copyright laws and is not for resale in any manner.

PUBLICATION ORDERING INFORMATION

LITERATURE FULFILLMENT:
Literature Distribution Center for ON Semiconductor
P.O. Box 5163, Denver, Colorado 80217 USA
Phone: 303-675-2175 or 800-344-3860 Toll Free USA/Canada
Fax: 303-675-2176 or 800-344-3867 Toll Free USA/Canada
Email: orderlit@onsemi.com

N. American Technical Support: 800-282-9855 Toll Free
USA/Canada
Europe, Middle East and Africa Technical Support:
Phone: 421 33 790 2910
Japan Customer Focus Center
Phone: 81-3-5773-3850

ON Semiconductor Website: www.onsemi.com
Order Literature: <http://www.onsemi.com/orderlit>

For additional information, please contact your local Sales Representative